



Item: _____

Quantity: _____

Project: _____

60" Electric Restaurant Range

60" Electric Restaurant Range

Models: RRE-10 RRE-8GT12 RRE-6GT24 RRE-4GT36
 RRE-2GT48 RRE-GT60



Voltage: 208V 240V
Phase: 1 Phase 3 Phase

Options and Accessories

- 6" high S/S stub back in lieu of high shelf
- 1" thick griddle plate
- Griddle on right (Left hand side standard)
- Chrome griddle plate
- Grooved griddle (specify width: _____")
- 9" deep S/S front landing ledge, with or without sauce pan cutouts
- Additional oven racks
- Open storage cabinet base - add suffix "-XB"
- Cabinet doors
- Intermediate shelf
- 5" swivel casters (set of four - 2 locking)

Standard Features

- Stainless steel front, sides, control panel and kick plate including backguard and high shelf
- Stainless steel full width drip tray
- Oven - total 5 KW with low wattage "broiler" element
- Oven thermostat controls, 200°-500°F
- Five position heavy gauge chrome rack guides
- One chrome rack per oven
- Five surface porcelain oven interior
- 9" solid hot plate elements, 2KW each
- 3/4 thick polished steel griddle plate
- GT Griddle Series - standard with thermostat every 12"
- One year limited warranty, parts and labor



Intertek
3065360



Intertek

Royal Range of California, Inc.
3245 Corridor Dr. • Eastvale, CA 91752 • (800) 769-2414 • (951) 360-1600
Fax: (951) 360-7500 • www.royalranges.com • sales@royalranges.com



60" Electric Restaurant Range

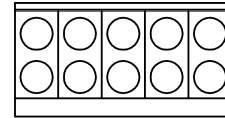
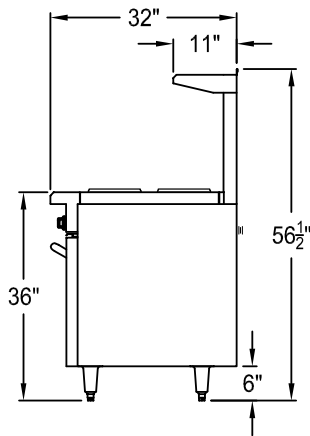
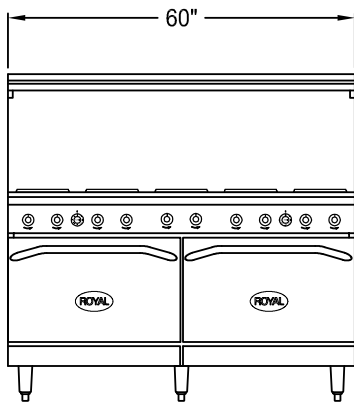

RRE-10

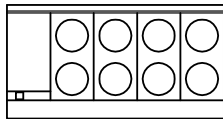

RRE-8GT12

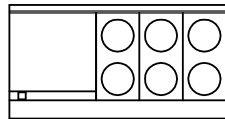

RRE-6GT24

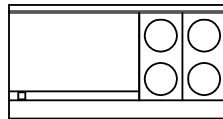

RRE-4GT36

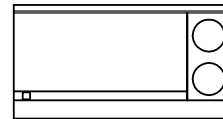

RRE-2GT48

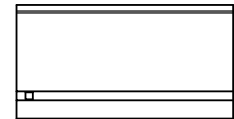

RRE-GT60

Model Number	Total KW	Voltage	A M P S				
			1 Phase		3 Phase		
			L1	L3	L1	L2	L3
RRE-10	30	208	145	145	92	94	94
		240	125	125	75	78	75
RRE-8GT12	29.4	208	142	142	92	90	88
		240	123	123	75	74	73
RRE-6GT24	28.8	208	139	139	88	86	88
		240	120	120	73	72	73
RRE-4GT36	28.2	208	136	136	94	92	90
		240	118	118	78	75	74
RRE-2GT48	27.6	208	133	133	90	88	90
		240	115	115	74	73	74
RRE-GT60	27	208	130	130	80	85	97
		240	113	113	70	71	84

To be installed only in noncombustible surroundings. See installation instructions.

Due to continuing product development to ensure best possible performance, these specifications are subject to change without prior notification.

Royal Range of California, Inc.
 3245 Corridor Dr. • Eastvale, CA 91752 • (800) 769-2414 • (951) 360-1600
 Fax: (951) 360-7500 • www.royalranges.com • sales@royalranges.com